

**CLEVER
FRAME[®]
MODULAR
SALES
SUPPORT
ARCHITEC-
TURE**

CLEVER FRAME® WORLDWIDE

HUNDREDS OF EMPLOYEES WORKING FOR THE SUCCESS OF THOUSANDS OF CUSTOMERS.

HUNDERTE MITARBEITER FÜR TAUSENDE VON KUNDEN.



MODULAR SALES SUPPORT ARCHITECTURE

CLEVER FRAME® PHILOSOPHY / CLEVER FRAME®-PHILOSOPHIE

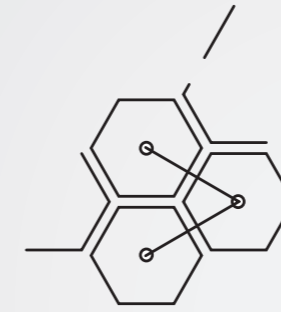

MODULAR

The key to success is efficiency. Our core idea is to create easy to assemble and transport modular systems. Our products are compatible, easy to reconfigure and redesign.

Effektiv zum Erfolg – mit unseren modularen Lösungen, die einfach aufzubauen und zu transportieren sind. Alle Produkte sind miteinander kompatibel und immer wieder neu gestaltbar.



SALES SUPPORT

Product presentation decides about clients' interest in a given brand. Our mission is to create sales points that encourage clients to come back.

Wir unterstützen Sie dabei, Ihre Produkte so zu präsentieren, dass Ihre Kunden begeistert sind und immer wieder kommen.

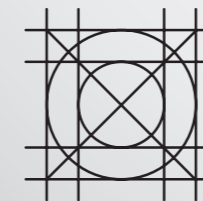

ARCHITECTURE

We cross borders between product exposition, exhibition, and architecture. Smart space requires in-depth brand analysis and proper ergonomics. That's exactly what we do at Clever Frame® International.

Hier zerfließen die Grenzen zwischen Produktpräsentation, Messebau und Architektur. Durchdacht, analysiert, auf den Nutzer angepasst.

“

Easy and intuitive system, interesting reconfiguration possibilities.

Leicht und intuitiv zu bedienen mit interessanten Konfigurationsmöglichkeiten.



“

Innovative approach to marketing and exhibition.

Marketing und Messebau innovativ gedacht.



“

Easy configuration of Clever Frame® is definitely worth recommending.

Die Konfigurationsleichtigkeit ist unbedingt empfehlenswert.



“

Perfect solution for presenting new and innovative products.

Perfekt für die Präsentation innovativer Produkte.



“

Ensures reconfigurations and fast changes in brand communication.

Ermöglicht schnellen Umbau und Message-Wechsel.



“

Excellent promotion tool.

Ein perfektes Promotion-Instrument.



“

Intuitive, easy, and very effective!

Intuitiv und einfach, dabei so effektiv!



“

With Clever Frame® we have increased promotional activities without additional costs.

Mehr Promotion-Veranstaltungen ohne zusätzliche Kosten.





EASY TRANSPORTATION
EINFACHER TRANSPORT

Light aluminium frames are easy to transport on Clever Frame® trolleys.

Problemloser Transport der leichten Rahmen mit passenden Wagen.

MODULARITY WITHOUT ANY TOOLS
MODULAR OHNE WERKZEUG

With our patented connectors, reconfigurations have never been easier - assemble the frames without any tools.

Durch spezielle Verbindungen kinderleicht und schnell zu montieren.



PANELS IN A FEW SECONDS
BLITZSCHNELLE PANEELLE

Within seconds put the magnetic graphic panels into the frames. You may exchange them individually, whenever you want to.

Die Grafikpaneele werden in Sekundenschnelle angebracht – jederzeit einzeln austauschbar.

HOW DOES IT WORK?
WIE FUNKTIONIERT ES?

SAVING MONEY KOSTEN SPAREN

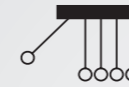

INCREASED SAFETY AND EFFECTIVENESS

KOSTENSICHER UND EFFEKTIV

Modular solutions mean safety and comfort. With Clever Frame® you are able to make fast marketing decisions. Every time you use the system, you build up the professional image of your brand.

Modulare Lösungen geben Kostensicherheit und Komfort. Schnelle Marketingentscheidungen werden möglich, und jeder Einsatz stärkt das Markenimage.



ONE SYSTEM FOR MANY PURPOSES

EIN SYSTEM, VIELE EINSATZMÖGLICHKEITEN

Clever Frame® equals savings. Today you may need an exhibition stand, tomorrow an event wall. Regardless of your needs, you can create functional constructions.

Heute ein Messestand, morgen eine Eventwand – bauen Sie, was Sie möchten, und sparen Sie modular.



NO NEED FOR DISPOSABLE SOLUTIONS

EINMALLÖSUNGEN ADE!

Clever Frame® is a reusable solution. You do not need to buy disposable stands and worry about their quality and esthetics. Focus on savings thanks to the ability to reuse our system.

Setzen Sie Clever Frame® immer wieder ein, statt Einmüllösungen zu nutzen, und sparen Sie beim Marketingbudget.



EASY IMAGE CHANGES

EINFACHER IMAGEWECHSEL

Rebranding? Seasonal offers? New Strategy? While changing your brand's image you do not need to invest in extra stands. You can change the graphic panels instantly and generate considerable savings.

Ob Rebranding, Saisonabverkauf oder neue Strategie: Die Basis bleibt, nur die Grafikpaneele werden ausgetauscht.



SAVE MONEY EACH TIME YOU USE THE SYSTEM

KOSTEN SPAREN BEI JEDEM EINSATZ

MODULAR MULTIFUNCTIONALITY MODULARE MULTIFUNKTIONALITÄT

Adjust the shape of your stand, exchange graphic panels, add shelves, TV sets or decorative elements to entirely change your stand.

Mehr als Formveränderung: Verändern Sie Ihren Stand mit neuen Grafikpaneelen, Regalen, TVs oder Dekoelementen.



ONE SYSTEM, MANY FUNCTIONS, HUNDREDS OF RECONFIGURATIONS
EIN SYSTEM, VIELE FUNKTIONEN, NOCH MEHR KONFIGURATIONEN

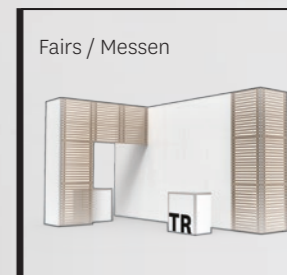
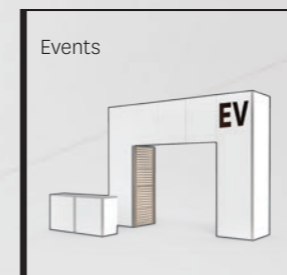
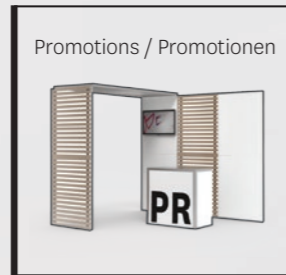

EVEN MORE POSSIBILITIES IMMER MEHR MÖGLICHKEITEN

See how much time and money you can save when you use one system for many purposes. The bigger your set is, the more marketing possibilities arise.

Sparen Sie Kosten durch mehrmaligen Einsatz desselben Systems – und ergänzen Sie es, wenn es das Budget zulässt. Mit jedem neuen Set wachsen die Konfigurationsmöglichkeiten.

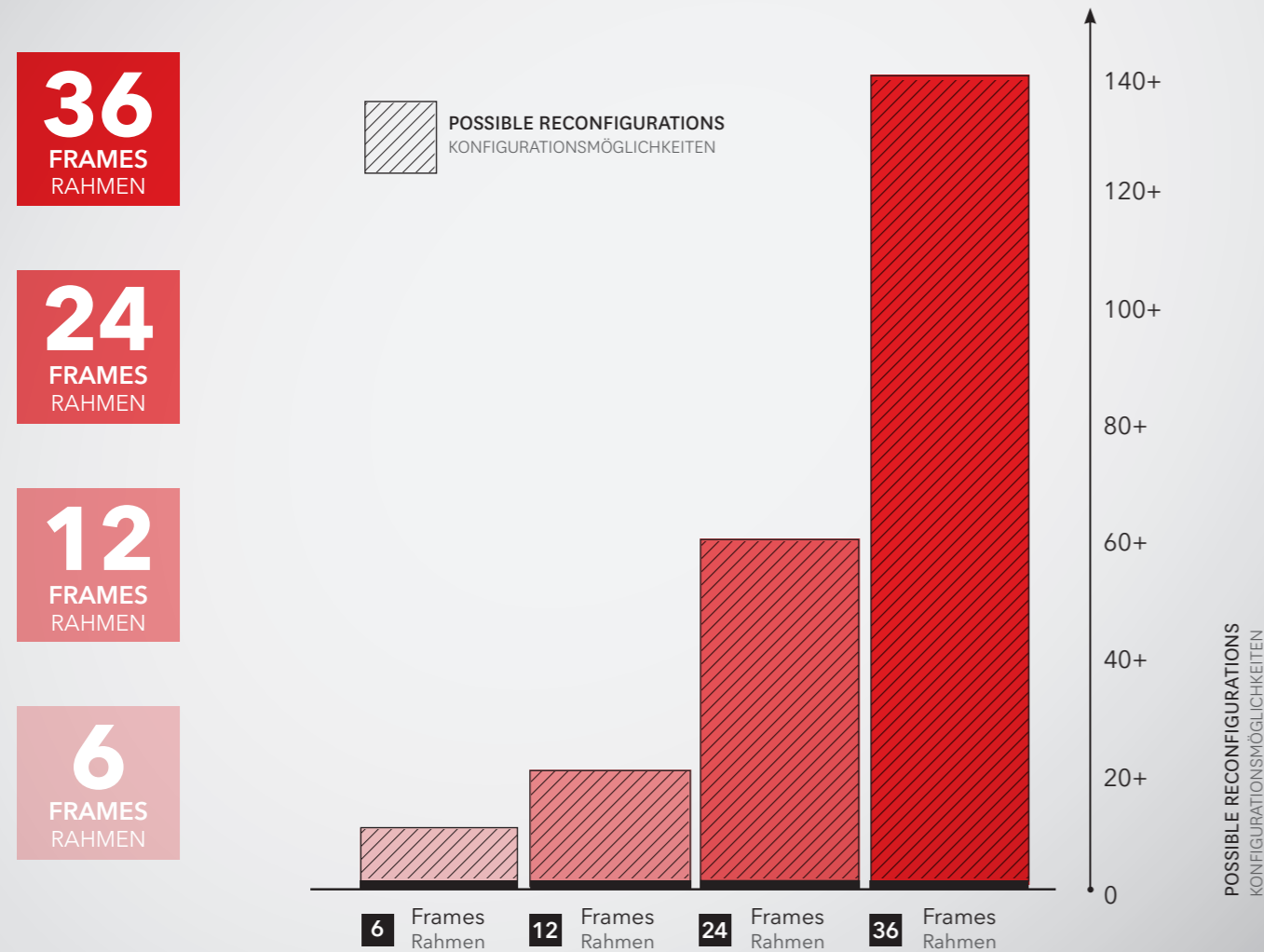

COMFORTABLE TRANSPORT LEICHTER TRANSPORT



FLIGHT CASE DAS SYSTEM-CASE

is capacious and durable, designed to store and transport frames, panels, and accessories.

ist robust und garantiert einfachen Transport und sichere Aufbewahrung der Paneele.

TROLLEY FOR FRAMES DER RAHMENWAGEN

allows you to transport up to 6 frames and easily fits in a car.

fasst 6 Rahmen für einfacheren Transport und passt in einen Pkw.

GRAPHIC PANELS CARRY BAG DIE PANEELTASCHE

is durable and guarantees easy transportation and safe panels storage. Easy to carry, fits in a car.

ist groß und robust – für alle Teile des Systems, zum Transport oder zur Aufbewahrung.

**CLEVER
FRAME[®]
MODULAR
SALES
SUPPORT
ARCHITEC-
TURE**

“

Working directly with the clients, we analyze their needs and expectations. We invest in product development to meet the market and clients' needs.

Ständige Markt- und Kundenanalysen tragen dazu bei, dass wir unser System immer weiterentwickeln und kundenorientiert verbessern.

Marcin Zieliński,
Sales Director



**CLEVER
FRAME[®]
MODULAR
SALES
SUPPORT
ARCHITEC-
TURE**

**CLEVER
FRAME[®]**

www.cleverframe.com

6 FRAMES SET / 6-RAHMEN-SET

Promotion space, info point, mobile reception desk or presentation stand.

Für Promotion- oder Infopunkte, mobile Empfangstheken oder Präsentationswände.



EXEMPLARY RECONFIGURATIONS / BEISPIEL-KONFIGURATIONSBEISPIELE



12 FRAMES SET / 12 RAHMEN-SET

For small fair stands or product exposition.

Für kleinere Messestände oder Promotionflächen.



EXEMPLARY RECONFIGURATIONS / BEISPIEL-KONFIGURATIONSBEISPIELE



24 FRAMES SET / 24-RAHMEN SET

Medium set gives you considerable reconfiguration possibilities to increase marketing activities.

Vielfältige Aufbaumöglichkeiten für effizienteres und effektiveres Marketing.



EXEMPLARY RECONFIGURATIONS / BEISPIEL-KONFIGURATIONSBEISPIELE

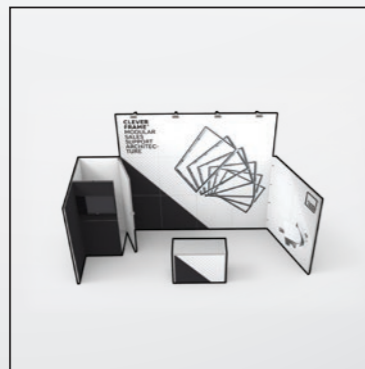

36 FRAMES SET / 36-RAHMEN-SET

Bigger, attractive, multifunctional stands and sales points.

Für große, ansprechende und multifunktionale Stände und Verkaufspunkte.



EXEMPLARY RECONFIGURATIONS / BEISPIEL-KONFIGURATIONSBEISPIELE



PRESENTATION AND FUNCTIONALITY PRÄSENTATION UND FUNKTIONALITÄT

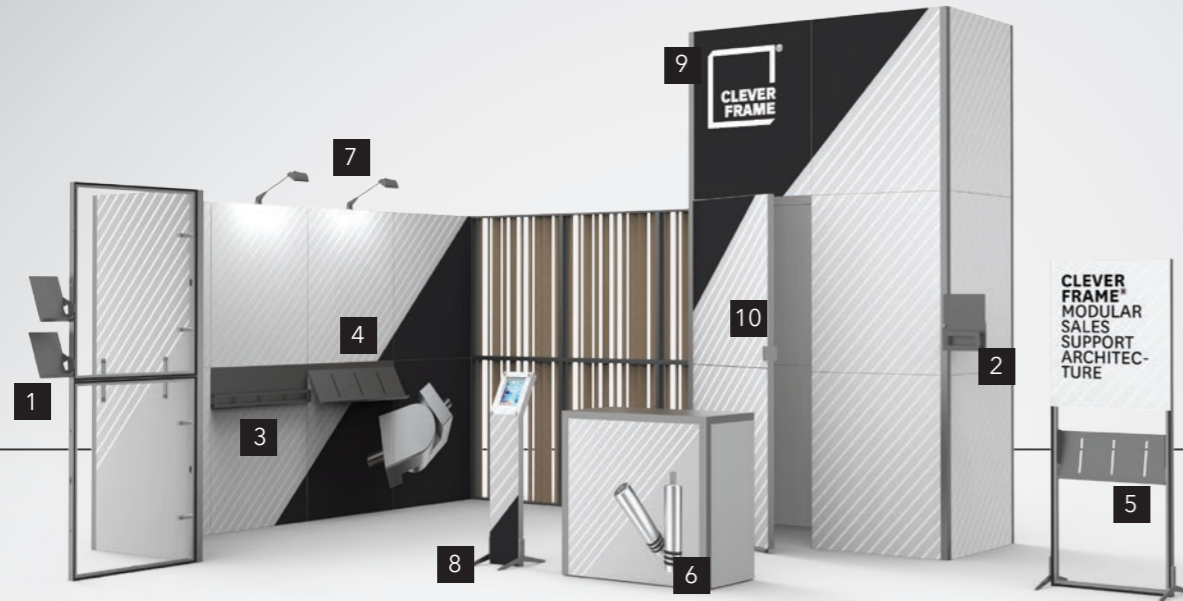

1. LEAFLET HOLDER /
PROSPEKTHALTER



6. CLEVER FRAME®
COUNTER / CLEVER
FRAME®- THEKE



2. LEAFLET HOLDER
FOR UPPER PROFILE /
PROSPEKTHALTER
FÜR ABSCHLUSSPROFILE



7. LED AND HALOGEN
LAMP / LED- UND
HALOGENLAMPEN



3. STRAIGHT LEAFLET
HOLDER / GERADER
PROSPEKTHALTER



8. PYLON WITH TABLET /
PYLON MIT TABLET
-HALTERUNG



4. SLANTING LEAFLET
HOLDER / SCHRÄGER
PROSPEKTHALTER



9. BACKLIT PANEL /
HINTERLEUCHTETES
PANEEL



5. LEAFLET HOLDER
FOR PYLONS /
PROSPEKTHALTER
FÜR PYLONEN



10. DOOR SYSTEM / TÜR



MULTIMEDIA AND DECORATION MULTIMEDIA UND DEKORATION



11. TV HOLDER /
TV-HALTERUNG

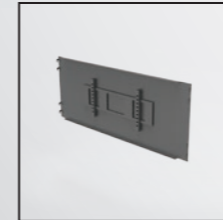

16. TRANSPORT SOLUTION /
TRANSPORTLÖSUNGEN



12. TABLET HOLDER /
TABLET-HALTERUNG

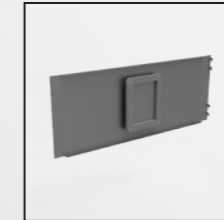

17. WOODEN PANEL /
HOLZPANEEL



13. SHELF / REGAL

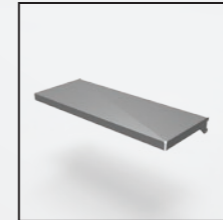

18. PLEXI PANEL /
PLEXIGLAS-PANEEL

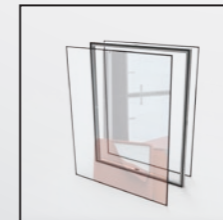

14. HINGES / SCHARNIERE



19. LATTERAL SUPPORT /
STÜTZFUSS



15. A-FRAME - SLANTING
FRAME / A-FRAME,
ABGESCHRÄGTER RAHMEN

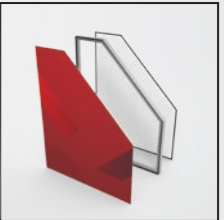

20. R-FRAME CURVED
FRAME / R-FRAME,
GEBOGENER RAHMEN



**CLEVER
FRAME®
MODULAR
SALES
SUPPORT
ARCHITEC-
TURE**

“

Clever Frame® is designed to create an effective exposition space, easy to remodel and rebrand, to highlight marketing communication and create professional brand image.

Clever Frame® ist aus dem Wunsch vieler Kunden entstanden, einen Stand zu haben, den man immer wieder neu arrangieren und gestalten kann, um die Marke professionell zu kommunizieren.

Filip Grudziński,
CEO



PROMOTE VARIOUS PRODUCTS
JEDES PRODUKT PERFEKT PRÄSENTIERT



THINK ABOUT EVERY DETAIL
BIS INS DETAIL DURCHDACHT



INVITE TO YOUR BRAND'S WORLD
DIE GANZE MARKENWELT IN EINEM STAND



PRESENT PROFESSIONALISM, BUILD TRUST
VERTRAUENSWÜRDIG, PROFESSIONELL



FOSTER BRAND CONSISTENCY
PASSEND ZUM MARKENIMAGE



PLAY WITH COLOR AND SHAPE
FÜR FARB- UND FORMSPIELE



FOSTER TANGIBLE BRAND COMMUNICATION
KUNDENKOMMUNIKATION



**CLEVER
FRAME®
MODULAR
SALES
SUPPORT
ARCHITECTURE**

“

Innovation does not equal technology, true innovation is inspired by changes in customer behavior, to create thought-through solutions - like the Clever Frame® system.

Innovation hat nicht nur mit Technologien zu tun, sondern auch mit Verhaltensänderungen durch neue Lösungen – wie bei Clever Frame®.

Rafat Modlinger,
Creative Director



TELL THE STORY BEHIND YOUR BRAND
ERZAHL DIE GESCHICHTE DEINER MARKE



INDICATE PROFESSIONALISM
KOMPETENZ ZUM ANFASSEN



CREATE COMFORTABLE DESIGNS FOR YOU AND YOUR CLIENTS
KOMFORTABLE RÄUME FÜR SIE UND IHRE KUNDEN



FORM MULTIFUNCTIONAL STANDS
MULTIFUNKTIONALE STÄNDE



ADJUST THE SYSTEM TO YOUR NEEDS
INDIVIDUELLER AUFBAU



ESTABLISH PROFESSIONAL BRAND IMAGE
PROFESSIONELLE IMAGEBILDUNG



PRESENT INNOVATION WITH CUTTING-EDGE STANDS
INNOVATION FÜR INNOVATIONEN



**CLEVER
FRAME[®]
MODULAR
SALES
SUPPORT
ARCHITEC-
TURE**



Our products are multifunctional, easy to transport and assemble, designed to create significant savings. This was our main goal.

Unsere Systeme sind multifunktional, mehrfach verwendbar, einfach und schnell ohne Werkzeug aufzubauen und dadurch kostensparend. Und das war unser Ziel.

Artur Przyjałowski,
Managing Director



Promo1

25 STANDS FOR THE PRICE OF 1 25 STÄNDE ZUM PREIS VON 1

Set of 6 frames and accessories. Modular, multifunctional system with 25 ready-to-build configurations. Clever Frame® philosophy captured in a Promo1 box.

6 Rahmen, Ablage und weiteres Zubehör: Aus der Basis des Clever Frame®-Systems lassen sich 25 unterschiedliche Stände bauen.



SEE MORE AT /
MEHR ERLEBEN:
WWW.PROMO-1.EU
WWW.PROMO-1.NET

PROMO1

EXEMPLARY RECONFIGURATIONS / BEISPIELKONFIGURATIONEN



Promo1

Build each stand in a couple of minutes, without any tools. Add accessories to increase Promo1 functionality. Transport your set in an estate car.

Der Aufbau: In weniger als 15 Min. und ohne Werkzeug. Einfach zu transportieren und mit weiterem Zubehör zu erweitern.



PYLONS
PYLONEN

CLASSIC PRESENTATION / KLASSISCHE PRÄSENTATION

Classic freestanding constructions, multifunctional and durable. Universal marketing tools with exchangeable graphic panels.

Die klassische, freistehende Konstruktion mit vielfältigen Ausbaumöglichkeiten. Stabil und robust, lässt sie sich mit immer neuen Grafikpaneelen für jeden Marketingeinsatz entsprechend gestalten.



DESIGN AND FUNCTIONALITY / ANSPRECHEND UND FUNKTIONAL

Add accessories to adjust pylons to your needs - e.g. use backlit panels for impressive product presentation.

Mit Zubehör werden Pylonen an Ihre Bedürfnisse angepasst – z.B. mit hinterleuchteten Paneelen für eindrucksvolle Produktpräsentation.



1. LEAFLET HOLDER / PROSPEKTHALTER
2. INTERNAL LEAFLET HOLDER / INTERNER PROSPEKTHALTER
3. LATERAL SUPPORT / STÜTZFUSS
4. TV
5. SHELF / REGAL
6. BASIS / PYLONBASIS

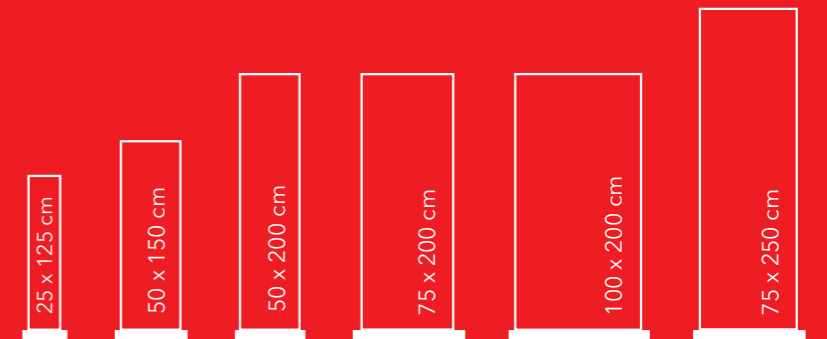

PYLONS
PYLONEN

The aluminum frame is light and durable. Easily replaceable magnetic graphic panels for each marketing campaign.

Der Alu-Rahmen ist leicht und robust. Durch Austausch der Grafik-Paneele werden die Pylonen an die jeweilige Marketingaktion angepasst.

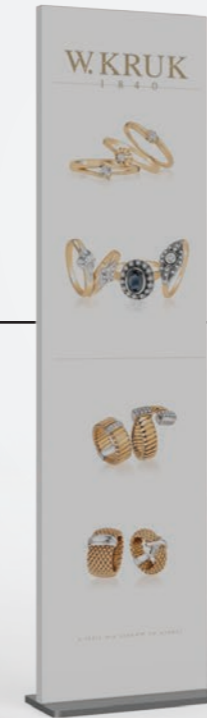
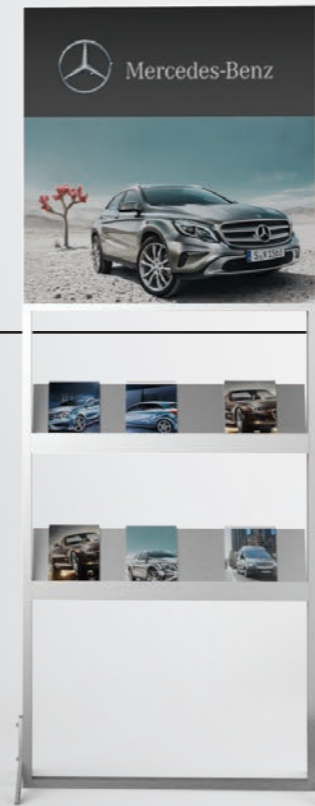

SHOWCASES
VITRINEN

MOBILE SHOWCASES / MOBILE VITRINEN

Showcases are perfect for elegant product presentation. The cabinets will match your brand image thanks to replaceable graphic panels.

Vitrinensockel erlauben eine elegante, außergewöhnliche Produktpräsentation – durch Grafikpaneele natürlich optisch auf die Marke abgestimmt.



ACCESSORIES / ZUBEHÖR



REMOVABLE GLASS / ABNEHMBARES GLAS •

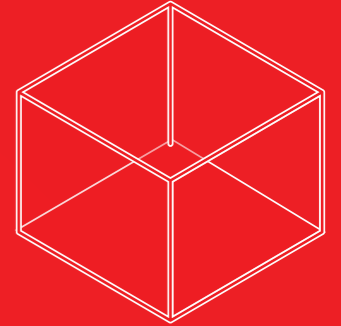

CABINET DOOR / VITRINE MIT TÜR •



CABINET LIGHTING SYSTEM / VITRINENBELEUCHTUNG •

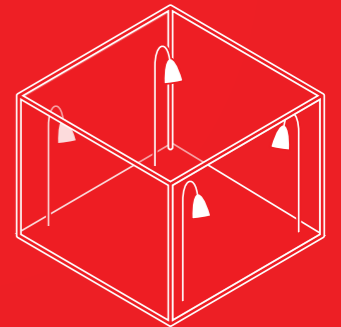

QUATRO

CLEVER QUATRO

Quatro is a perfect tasting stands system - light, mobile, and as attractive as your brand image.

Quatro ist perfekt für Verkostungsstände - leicht, mobil und genauso modern wie Ihre Marke.



ACCESSORIES / ZUBEHÖR

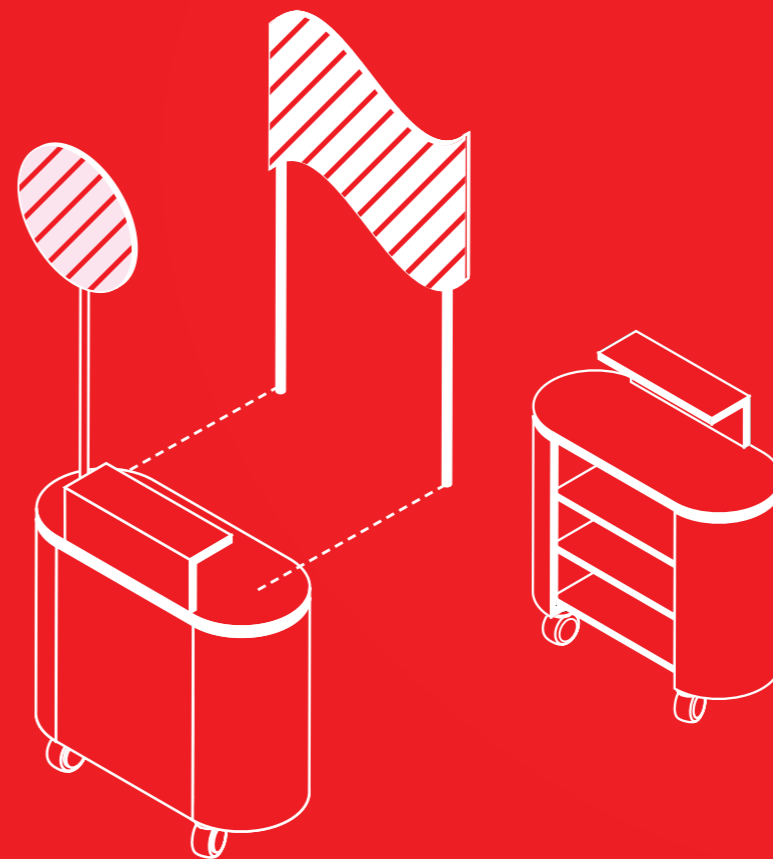

• TABLE TOP / ABLAGE



• SHELVES / REGALE



• LEVEL RAISER /
• AUFSATZ



• TOPPER / EINFACHES
• SCHILD



• DOUBLE TOPPER /
• DOPPELTES SCHILD



• LIGHTED FRONT PANEL /
• BELEUCHTETE FRONT



• WHEELS /
• TRANSPORTRÄDER

QUATRO



BARS CF

BARS AND COUNTERS / BARS UND THEKEN

Modular, mobile and easy to assemble: bars and counters are ideal for many events and other promotional activities.

Modular, mobil und schnell montiert: Die Bars und Theken passen ideal in die schnelllebige Event- und Promotionwelt.



SIZES AND ACCESSORIES / GRÖSSEN UND ZUBEHÖR

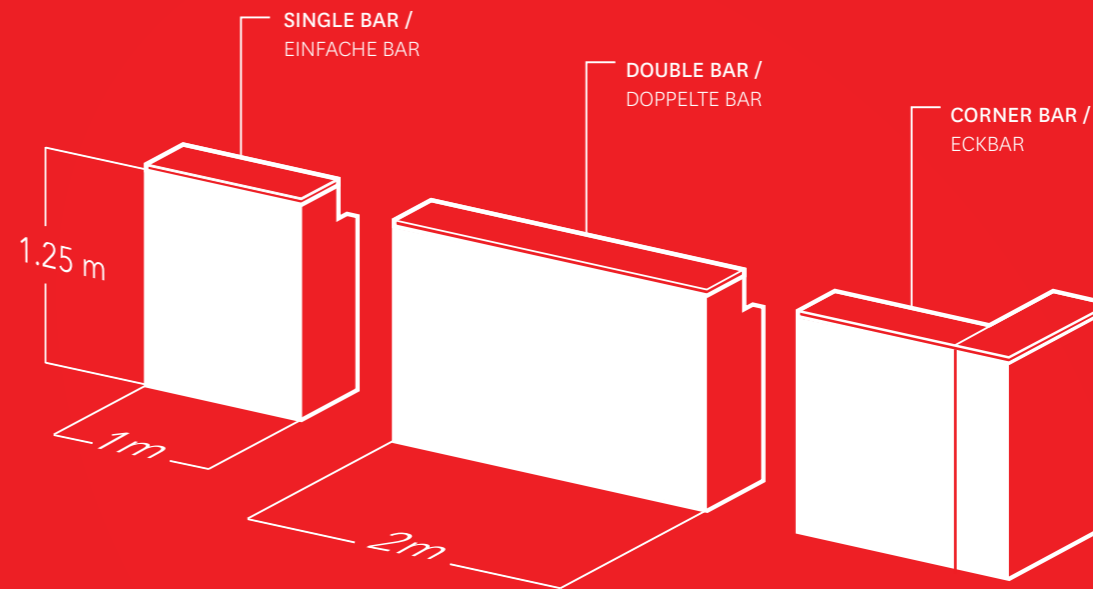

• ILLUMINATED PANEL /
BELEUCHTETES PANEEL



• ILLUMINATED COUNTER /
BELEUCHTETE ABLAGE



• TOP - 75CM HEIGHT,
ADDITIONAL SHELVES /
ARBEITSPLATTE 75CM
HÖHE, ZUSÄTZLICHE
REGALE



• ACCESSORIES /
ZUBEHÖR



• TRANSPORT

BARS CF

Adjust Clever Frame® bars and counters to your needs, arrange and rearrange single, double and corner bars.

Clever Frame® Bars können als Eck- oder Reihenbars aufgestellt werden, je nach Platz- und Eventgröße.



COUNTER
THEKEN

SEMICIRCULAR COUNTER / HALBRUNDE THEKEN

Rounded shape of the counter comes in handy while arranging attractive and functional stands. Easy to assemble and rearrange.

Bringt Abwechslung in jeden Aufbau, z.B. als Formenbruch in einem geradlinigen Messestand. Natürlich ganz einfach in der Montage.

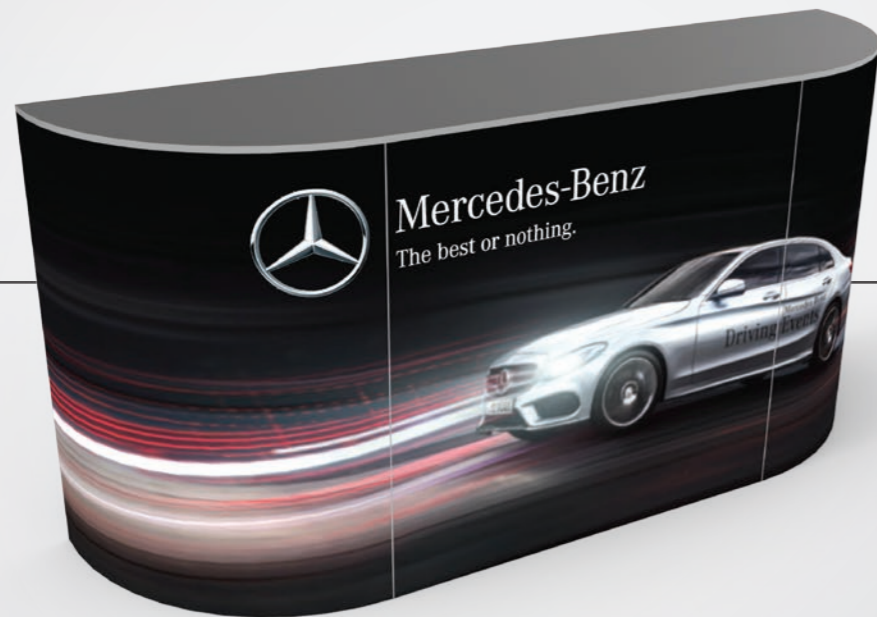

3DFRAME

3D FRAME

3d product presentation for enhanced brand experience. Endless possibilities, 3d stands can be connected with Clever Frames®.

Produktpräsentation, die in die Tiefe geht – erweitern Sie Ihre Möglichkeiten durch 3D-Elemente, die alle mit den Rahmen kombinierbar sind.



A-frame

A-FRAME

Play with form, add the break-through and extraordinary A-frame to your Clever Frame® stand or combine many A-frames together.

Stilbruch mit Formenbruch durch das außergewöhnliche A-Rahmenformat wirkt alleinstehend oder zusammen mit anderen Rahmen.



**CLEVER
FRAME®
MODULAR
SALES
SUPPORT
ARCHITEC-
TURE**



At Clever Frame we implement the CSR strategy, because as an employer and franchisor we feel co-responsible for shaping the global labour market. We pay attention to choosing only reliable and responsible sub-suppliers. Respect, fair treatment, and solicitude are key to work safety and brand transparency.

Nachhaltiges Denken prägt nicht nur unsere Produkte, sondern auch unseren Alltag – den CSR-Ansätzen folgend, legen wir besonderen Wert auf einen fairen und vertrauensvollen Umgang mit unseren Geschäftspartnern und Mitarbeitern, auf Arbeitssicherheit und soziale Aspekte. Bei der Wahl von Zulieferern achten wir darauf, dass sie die gleichen Werte achten wie wir.

Kamil Kozak,
Production Manager



FRAMES / RAHMEN

D1

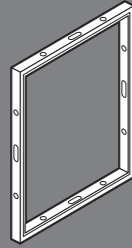

Frames / Rahmen D1 - 100 x 75 cm

C1

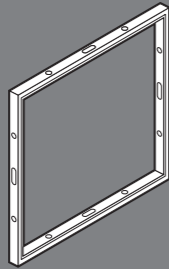

Frames / Rahmen C1 - 100 x 100 cm

DC1.1



Frames / Rahmen DC1.1 - 100 x 50 cm

DC1.2



Frames / Rahmen DC1.2 - 100 x 25 cm

D2

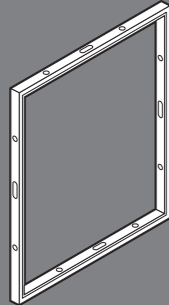

Frames / Rahmen D2 - 125 x 100 cm

D2.1

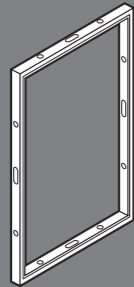

Frames / Rahmen D2.1 - 125 x 75 cm

D2.2



Frames / Rahmen D2.2 - 125 x 50 cm

D2.3



Frames / Rahmen D2.3 - 125 x 25 cm

RS.D2

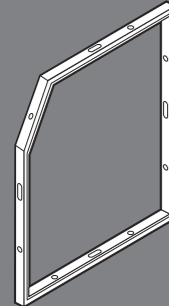

Frames / Rahmen A-Frame D2

RT.D1.1

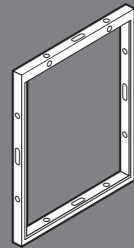

Technical frame D1 75 cm /
Technischer Rahmen D1 75 cm

RT.D1.2

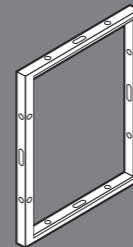

Technical frame D1 100 cm /
Technischer Rahmen D1 100 cm

RT.D2.2

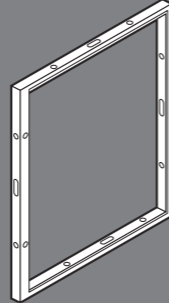

Technical frame D2 125 cm /
Technischer Rahmen D2 125 cm

RT.D2.1

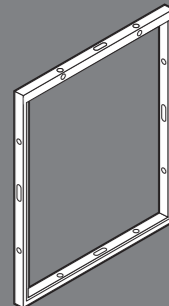

Technical frame D2 100 cm /
Technischer Rahmen D2 100 cm

RT.C1

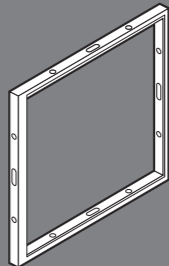

Technical frame C1 /
Technischer Rahmen C1

R1

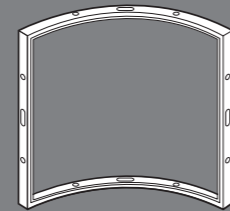

Curved frame R1 100 cm /
R1 Bogenrahmen 100 cm

R2

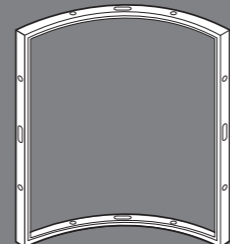

Curved frame R2 125 cm /
R2 Bogenrahmen 125 cm

CONNECTORS / VERBINDER

CON01

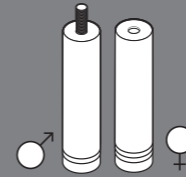

Connectors / Verbinders

CON01.M

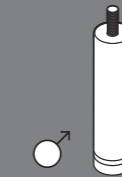

Connector - female /
Verbinder - weiblich

CON01.F

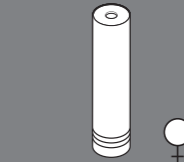

Connector - male /
Verbinder - männlich

ACS02.0

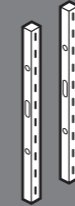

Support profile 100 cm (set - 2 pcs.) /
Stützprofil 100 cm (Set je 2 Stück)

ACS02.1



Shelf profile 125 cm (set - 2 pcs.) /
Stützprofil für Ablage 125 cm
(Set je 2 Stück)

ACS03.75



Shelf / Regal 75 x 28 cm

ACS03.100

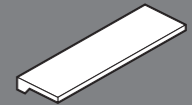

Shelf / Regal 100 x 29 cm

HOL.75

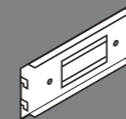

TV holder for 75 cm frame
TV-Halterung 75 cm Rahmen

HOL.100

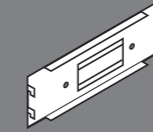

TV holder for 100 cm frame /
TV-Halterung 100 cm Rahmen

LH01.R



Leaflet holder A4 - right /
Prospekthalter A4 - rechts

LH01.L

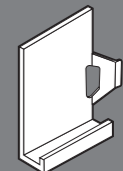

Leaflet holder A4 - left /
Prospekthalter A4 - links

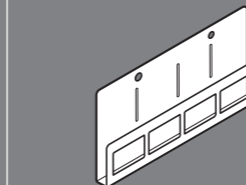

Straight leaflet holder for the technical
frame/ Gerader Prospekthalter für den
technischen Rahmen:
LHT01.75 - 75 cm
LHT01 - 100 cm

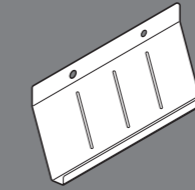

Slanting leaflet holder for the technical
frame/ Schräger Prospekthalter für den
technischen Rahmen:
LHT02.75 - 75 cm
LHT02 - 100 cm

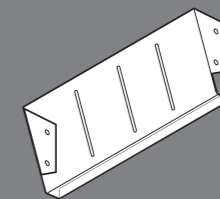

Leaflet holder for the pylon/ Interner
Prospekthalter für Pylone:
LH03.1 - 75 cm
LH03.2 - 100 cm

LH02



Leaflet holder for lateral
support profile /
Prospekthalter für Abdeckleisten

ACCESSORIES / ZUBEHÖR

ACCESSORIES / ZUBEHÖR

PYLON

ACL02



Halogen lamp 150 W /
Halogenlampe 150 W

ACL05



LED Lamp 20 W /
LED-Lampe 20 W

HIN01



Hinge / Scharnier

PL.075.D

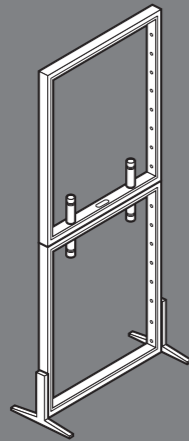

Pylon frame (2 elements) /
Rahmen für zweiteiligen Pylon
75 x 200 cm

PL.100.D

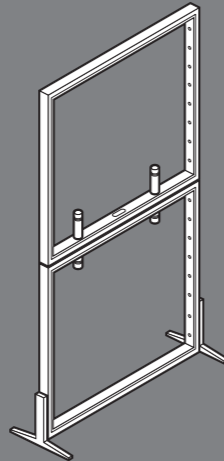

Pylon frame (2 elements) /
Rahmen für zweiteiligen Pylon
100 x 200 cm

PL.100

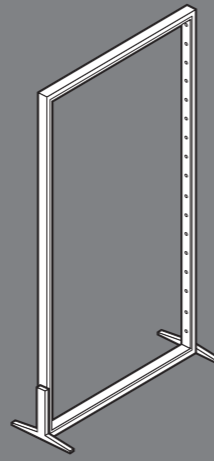

Pylon 100 x 200 cm

DOOR / TÜR

PL.075

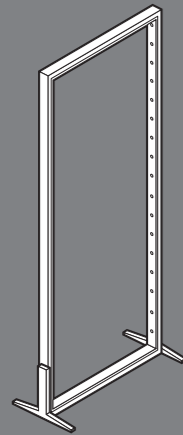

Pylon 75 x 200 cm

PL.050

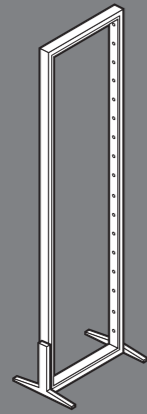

Pylon 50 x 200 cm

ACD200

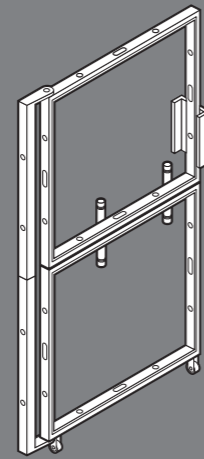

CF Door 200 cm /
CF Tür-System 200 cm

ACD250

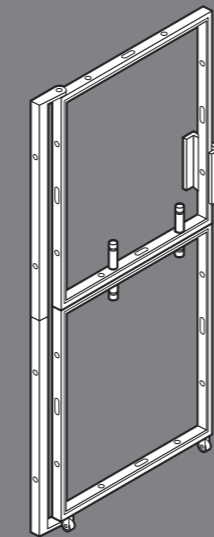

CF Door 250 cm /
CF Tür-System 250 cm

COUNTER / THEKE

CT135

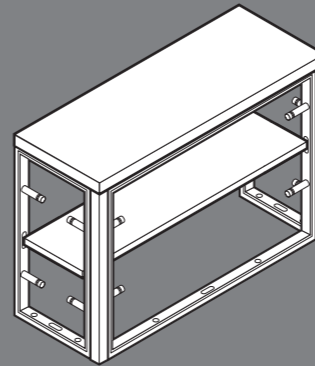

Clever Frame counter 135 cm /
Clever Frame Theke 135 cm

CT135.SEC

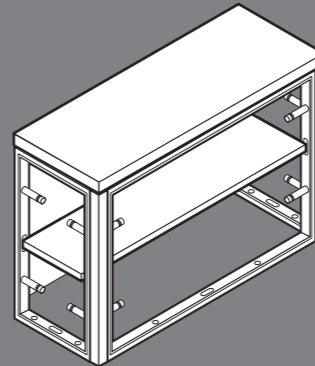

Clever Frame counter 135 cm,
door and lock /
Clever Frame Theke 135 cm,
abschließbar und Tür

ACS05

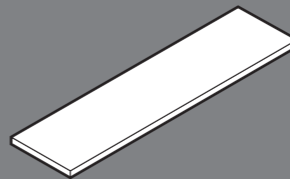

Shelf for the counter 135 cm /
Ablage für Theke 135 cm

CT110

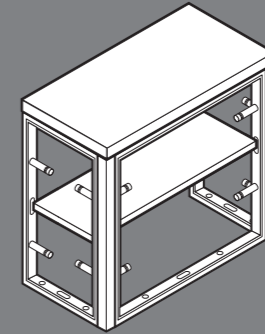

Clever Frame counter 110 cm /
Clever Frame Theke 110 cm

CT110.SEC

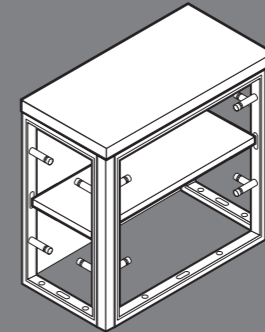

Clever Frame counter 110 cm,
door and lock /
Clever Frame Theke 110 cm,
abschließbar und Tür

ACS05.1

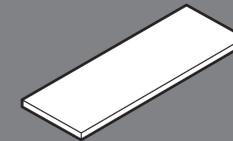

Shelf for the counter 110 cm /
Ablage für Theke 110 cm

CT85

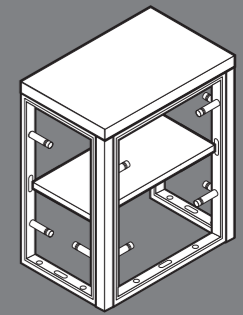

Clever Frame counter 85 cm /
Clever Frame Theke 85 cm

CT85.SEC

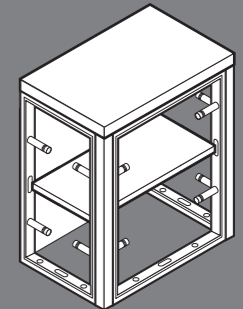

Clever Frame counter 85 cm,
door and lock /
Clever Frame Theke 85 cm,
abschließbar und Tür

ACS05.2

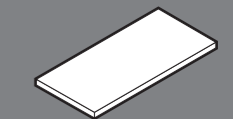

Shelf for the counter 85 cm /
Ablage für Theke 85 cm

COUNTER / THEKE

ACS06



Countertop 135 cm /
Abdeckplatte für Theke 135 cm

ACS06.1

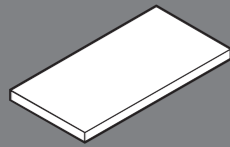

Countertop 110 cm /
Abdeckplatte für Theke 110 cm

ACS06.2

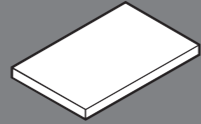

Countertop 85 cm /
Abdeckplatte für Theke 85 cm

ACS06.4

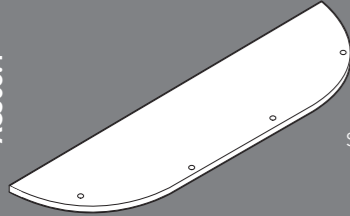

Semicircular countertop 235 cm /
Abdeckplatte für
Halbrundetheke 235 cm

ACS06.3

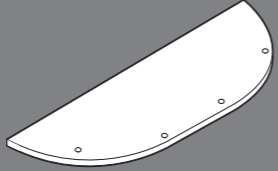

Semicircular countertop 185 cm
Abdeckplatte für Halbrundetheke 185 cm

CTR175
CTR225

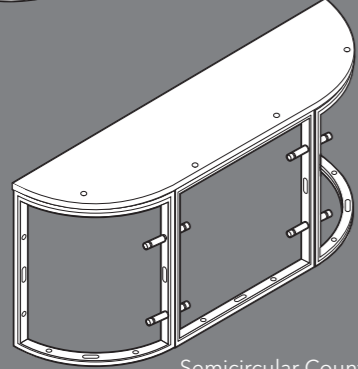

Semicircular Counter 185 cm / 235 cm
Halbrunde Theke 185 cm / 235 cm

QTR.KPL

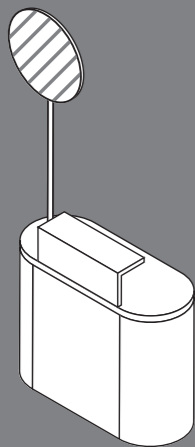

Clever Quatro

CT50

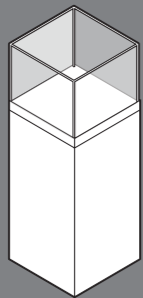

Mobile showcase
Mobile Vitrine

CT50.SEC

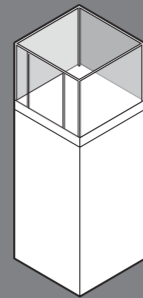

Mobile showcase - lockable
Mobile Vitrine - abschließbar

PL.IP

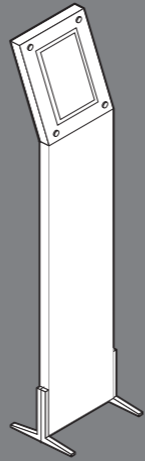

iPad pylon / iPad Pylon

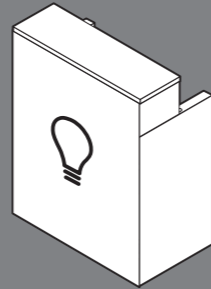

Illuminated bar counter /
Beleuchtete Bartheke

FLOOR / FUSSBODEN

FL01

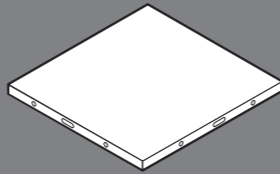

Clever Frame floor system /
Fußboden Clever Frame
100 cm x 100 cm

BAG / TASCHE

ACT07

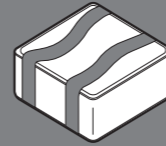

Connector bag /
Tasche für Verbinder

ACT08

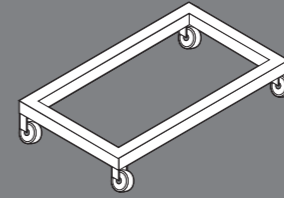

Aluminium Trolley (6 Frames) /
Aluminium-Trolley (6 Rahmen)

ACT10

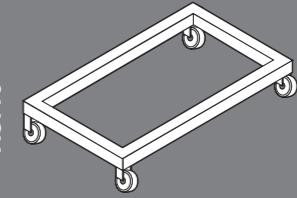

Aluminum Trolley for R-Frame /
Aluminium-Trolley
für Bogenrahmen

ACT09

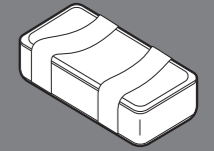

Carry bag for 6 lamps /
Transporttasche für 6 Lampen

ACT04

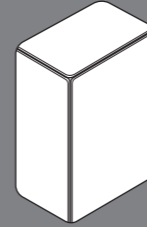

Trolley cover for D1 frames /
Schutzhülle für
Aluminium-Trolley D1

ACT05

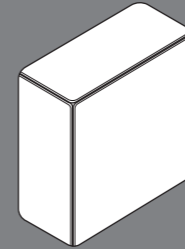

Trolley cover for C1 frames /
Schutzhülle für
Aluminium-Trolley C1

ACT06

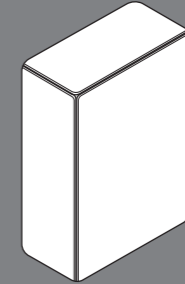

Trolley cover for D2 frames /
Schutzhülle für
Aluminium-Trolley D2

FLCS.01

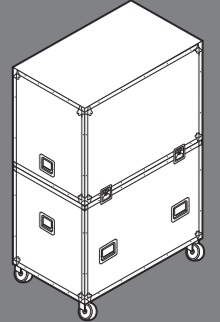

Universal Flight Case

PROMO 1

ACT03

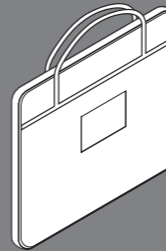

Carry bag for D2 Panels /
Transporttasche für
Grafik-Paneele D2

ACT02

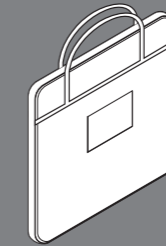

Carry bag for C1 Panels /
Transporttasche für
Grafik-Paneele C1

ACT01



Carry bag for D1 Panels /
Transporttasche für
Grafik-Paneele D1

PRM0

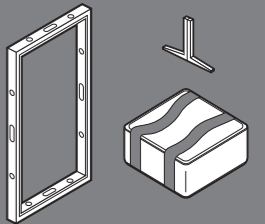

Promo1 Set excl. panels /
Promo1 ohne Paneele

PRM1

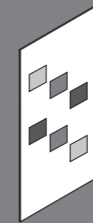

Promo1 Set

PRM1.PG

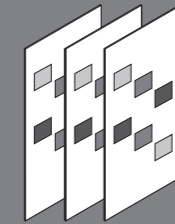

12 Promo1 Panels /
12 Promo 1 Paneelen

P1.BL

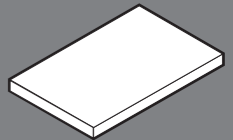

Promo1 Table Top /
Promo 1 Tischplatte

PANEL / PANEEL

PCV: PD1
PLEXI: PPD1
HIPS: PHD1

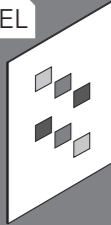

Panel / Paneel D1 100 x 75 cm

PCV: PC1
PLEXI: PPC1
HIPS: PHC1



Panel / Paneel C1 100 x 100 cm

PCV: PDC1.1
PLEXI: PPDC1.1
HIPS: PHDC1.1



Panel / Paneel DC1.1 100 x 50 cm

PCV: PDC1.2
PLEXI: PPDC1.2
HIPS: PHDC1.2



Panel / Paneel DC1.2 100 x 25 cm

PCV: PL.G050
PLEXI: PL.PG050
HIPS: PL.HG050

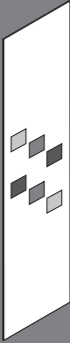

Graphic Panel for Pylon /
Grafik-Paneel für Pylon
50 x 200 cm

PCV: PL.G075
PLEXI: PL.PG075
HIPS: PL.HG075

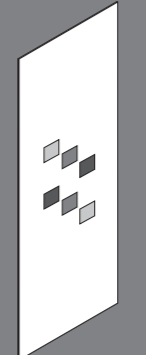

Graphic Panel for Pylon /
Grafik-Paneel für Pylon
75 x 200 cm

PCV: PL.G100
PLEXI: PL.PG100
HIPS: HL.HG100

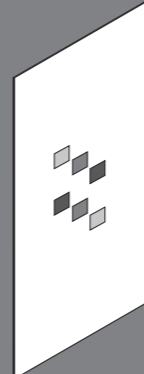

Graphic Panel for Pylon /
Grafik-Paneel für Pylon
100 x 200 cm

PCV: PD2
PLEXI: PPD2
HIPS: PHD2



Panel / Paneel D2 125 x 100 cm

PCV: PD2.1
PLEXI: PPD2.1
HIPS: PHD2.1

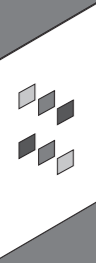

Panel / Paneel D2.1 125 x 75 cm

PCV: PD2.2
PLEXI: PPD2.2
HIPS: PHD2.2

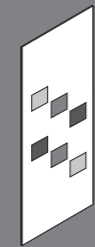

Panel / Paneel D2.2 125 x 50 cm

PCV: PD2.3
PLEXI: PPD2.3
HIPS: PHD2.3



Panel / Paneel D2.3 125 x 25 cm

PCV: PWD2
PLEXI: PPWD2
HIPS: PHWD2



Filler panel D2 /
Paneel D2 zur Rahmenfüllung

PCV: PWC1
PLEXI: PPWC1
HIPS: PHWC1

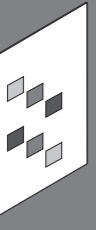

Filler panel C1 /
Paneel C1 zur Rahmenfüllung

PCV: PWD1
PLEXI: PPWD1
HIPS: PHWD1

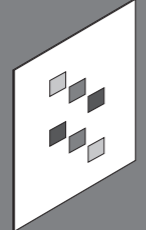

Filler panel D1 /
Paneel D1 zur Rahmenfüllung

PCV: PR1
PLEXI: PRP1
HIPS: PRH1

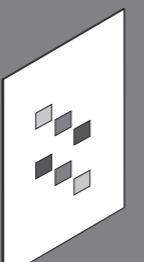

Filler panel R1, internal /
Innen-Paneel R1 zur Rahmenfüllung

PCV: PR1.1
PLEXI: PRP1.1
HIPS: PRH1.1



Filler panel R1.1, external /
Außen-Paneel R1.1 zur Rahmenfüllung

PROFILE I MASKOWNICE

PCV: PR2
PLEXI: PRP2
HIPS: PRH2



Filler panel R2, internal /
Innen-Paneel R2
zur Rahmenfüllung

PCV: PR2.1
PLEXI: PRP2.1
HIPS: PRH2.1



Filler panel R2.1, external /
Außen-Paneel R2.1
zur Rahmenfüllung

PDR.C1



Wooden panel 100 x 100 cm
- for C1 frame /
Holzpaneel 100 x 100 cm
- für C1 Rahmen

PDR.D2

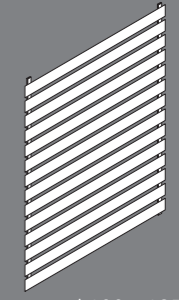

Wooden panel 100 x 125 cm
- for D2 frame /
Holzpaneel 100 x 125 cm
- für D2 Rahmen

SP075.05 - 75 cm
SP100.05 - 100 cm
SP125.05 - 125 cm



Ending profile /
Abschlussprofil

SP075.04 - 75 cm
SP100.04 - 100 cm
SP125.04 - 125 cm

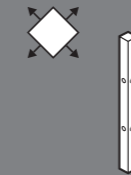

4-side threaded profile /
Profil, vierseitige Vernietung

SP075.03 - 75 cm
SP100.03 - 100 cm
SP125.03 - 125 cm

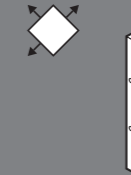

3-side threaded profile /
Profil, dreiseitige Vernietung

SP075.02 - 75 cm
SP100.02 - 100 cm
SP125.02 - 125 cm

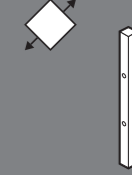

2-side threaded profile /
Profil, zweiseitige Vernietung

SP075.01 - 75 cm
SP100.01 - 100 cm
SP125.01 - 125 cm

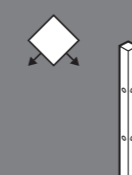

Corner profile /
Eckprofil

LS.075.01 - 75 cm
LS100.01 - 100 cm
LS125.01 - 125 cm

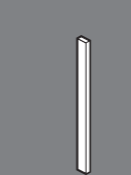

Upper profile /
Oberes Abschlussprofil

LS.075.0 - 75 cm
LS100.00 - 100 cm
LS125.00 - 125 cm

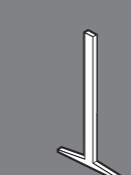

Lower support with leg /
Unteres Abschlussprofil
mit Standfuß

PL.S01

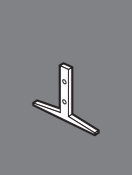

Pylon lateral support /
Standfuß für Pylonen

ACCESSORIES / ZUBEHÖR

P1.PD



Lateral support for Promo1 /
Stützfüße für Promo1

LSR.50



Lateral support profile for R-Frame /
Abschlussprofil für Bogenrahmen

ACS08

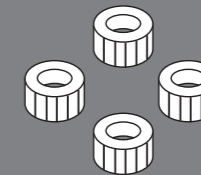

Mounting rings (4 pcs.)
Befestigungsring (4 Stück)

„Sailing and marketing have one thing in common: both require absolute perfection”

„Segeln und Marketing verbindet eines: Absolute Perfektion”

Przemysław Tarnacki

Multiple World Sailing Champion
Mehrfacher Segel-Weltmeister

At Clever Frame® International we look forward to new challenges. We shape global exhibition trends and help companies build cohesive brand image.

Bei Clever Frame® lieben wir Herausforderungen – dadurch können wir weltweit die Messebranche beeinflussen und helfen, Marken einheitlich in ihrer Corporate Identity zu kommunizieren.



CLEVER FRAME® YACHT DURING ALPARI WORLD MATCH RACING TOUR
CLEVER FRAME® -YACHT WÄHREND DER ALPARI WORLD MATCH RACING TOUR (WELTMEISTERSCHAFTEN)

